

MN139/24

DARWIN

22 November 2024

Mineral Titles Act
NOTICE OF GRANT OF A MINERAL TITLE

Title Type and Number: Exploration Licence 33844
Granted: 22 November 2024, for a period of 6 Years
Area: 246 Blocks, 710.35 km²
Locality: TURNERS DOME
Name of Holder/s: 100% WA1 RESOURCES LTD [ACN. 646 878 631]

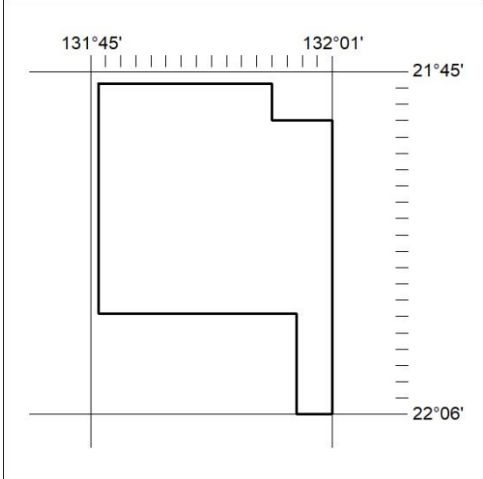

Area granted is indicated above. The titleholder is not permitted to exercise occupational rights on any land that is subject to a development title, or an application for a development title. Any land the subject of a Reserved Land gazettal under the *Mineral Titles Act* and all land vested in the Commonwealth of Australia is also excluded by description but not excised from the grant area.

416/24

Mineral Titles Act
NOTICE OF GRANT OF A MINERAL TITLE

Title Type and Number: Exploration Licence 33846
Granted: 22 November 2024, for a period of 6 Years
Area: 27 Blocks, 86.08 km²
Locality: CHILLA
Name of Holder/s: 100% WA1 RESOURCES LTD [ACN. 646 878 631]

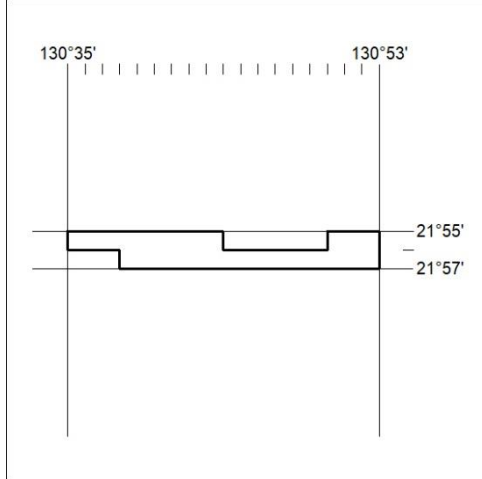

Area granted is indicated above. The titleholder is not permitted to exercise occupational rights on any land that is subject to a development title, or an application for a development title. Any land the subject of a Reserved Land gazettal under the *Mineral Titles Act* and all land vested in the Commonwealth of Australia is also excluded by description but not excised from the grant area.

418/24

Mineral Titles Act
NOTICE OF GRANT OF A MINERAL TITLE

Title Type and Number: Exploration Licence 33845
Granted: 22 November 2024, for a period of 6 Years
Area: 213 Blocks, 668.84 km²
Locality: GILES
Name of Holder/s: 100% WA1 RESOURCES LTD [ACN. 646 878 631]

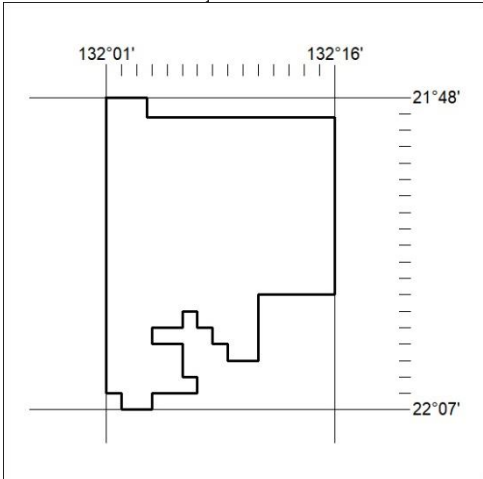

Area granted is indicated above. The titleholder is not permitted to exercise occupational rights on any land that is subject to a development title, or an application for a development title. Any land the subject of a Reserved Land gazettal under the *Mineral Titles Act* and all land vested in the Commonwealth of Australia is also excluded by description but not excised from the grant area.

417/24

Mineral Titles Act
NOTICE OF GRANT OF A MINERAL TITLE

Title Type and Number: Exploration Licence 33847
Granted: 22 November 2024, for a period of 6 Years
Area: 7 Blocks, 22.28 km²
Locality: DOREEN
Name of Holder/s: 100% WA1 RESOURCES LTD [ACN. 646 878 631]

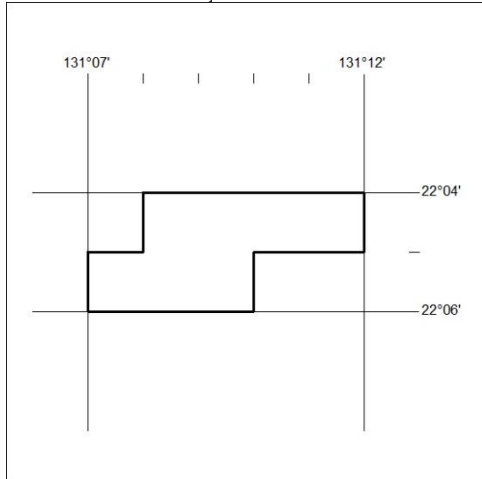

Area granted is indicated above. The titleholder is not permitted to exercise occupational rights on any land that is subject to a development title, or an application for a development title. Any land the subject of a Reserved Land gazettal under the *Mineral Titles Act* and all land vested in the Commonwealth of Australia is also excluded by description but not excised from the grant area.

419/24

MN139/24

DARWIN

22 November 2024

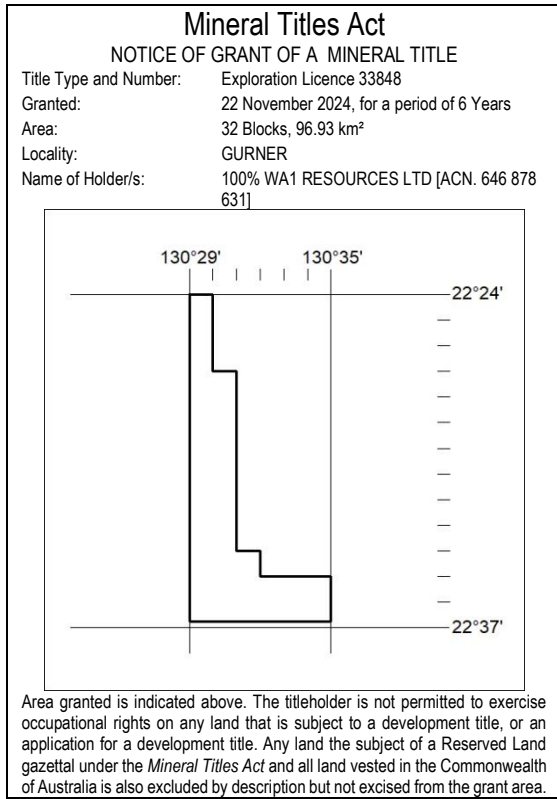

420/24

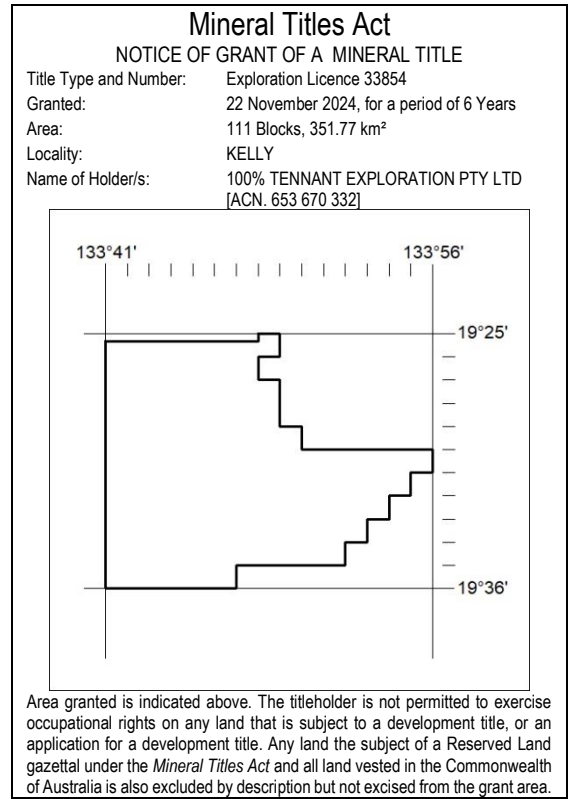

422/24

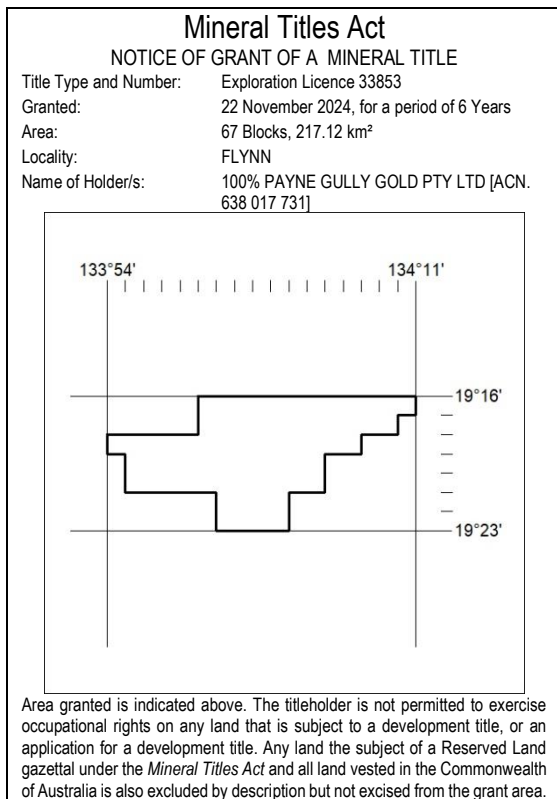

421/24

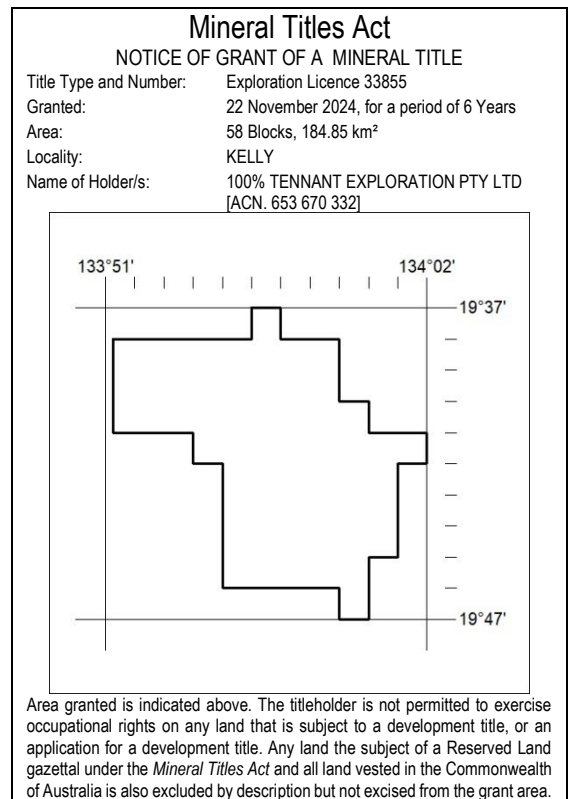

423/24

MN139/24

DARWIN

22 November 2024

Mineral Titles Act
NOTICE OF GRANT OF A MINERAL TITLE

Title Type and Number: Exploration Licence 33856
 Granted: 22 November 2024, for a period of 6 Years
 Area: 11 Blocks, 35.59 km²
 Locality: TENNANT CREEK
 Name of Holder/s: 100% TENNANT EXPLORATION PTY LTD
 [ACN. 653 670 332]

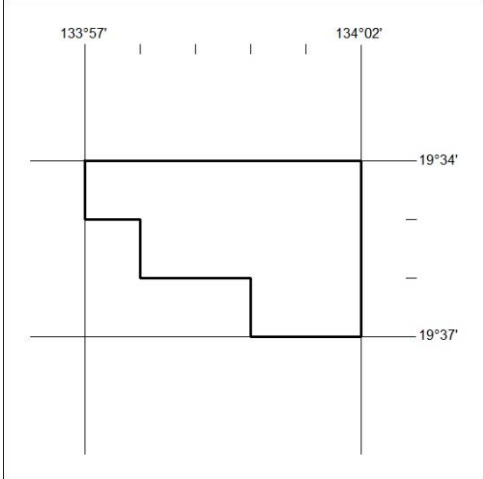

Area granted is indicated above. The titleholder is not permitted to exercise occupational rights on any land that is subject to a development title, or an application for a development title. Any land the subject of a Reserved Land gazettal under the *Mineral Titles Act* and all land vested in the Commonwealth of Australia is also excluded by description but not excised from the grant area.

424/24

Mineral Titles Act
NOTICE OF GRANT OF A MINERAL TITLE

Title Type and Number: Exploration Licence 33858
 Granted: 22 November 2024, for a period of 6 Years
 Area: 5 Blocks, 16.20 km²
 Locality: FLYNN
 Name of Holder/s: 100% TENNANT EXPLORATION PTY LTD
 [ACN. 653 670 332]

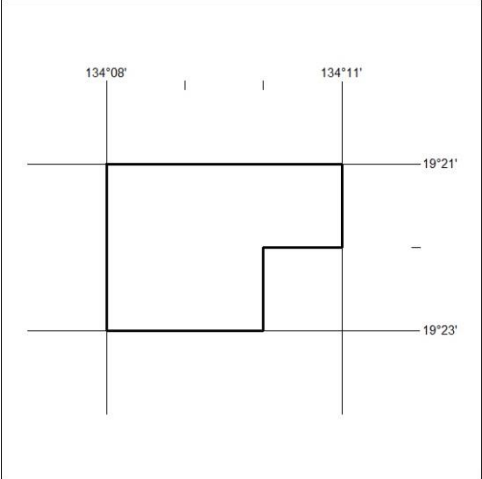

Area granted is indicated above. The titleholder is not permitted to exercise occupational rights on any land that is subject to a development title, or an application for a development title. Any land the subject of a Reserved Land gazettal under the *Mineral Titles Act* and all land vested in the Commonwealth of Australia is also excluded by description but not excised from the grant area.

426/24

Mineral Titles Act
NOTICE OF GRANT OF A MINERAL TITLE

Title Type and Number: Exploration Licence 33857
 Granted: 22 November 2024, for a period of 6 Years
 Area: 6 Blocks, 19.43 km²
 Locality: FLYNN
 Name of Holder/s: 100% TENNANT EXPLORATION PTY LTD
 [ACN. 653 670 332]

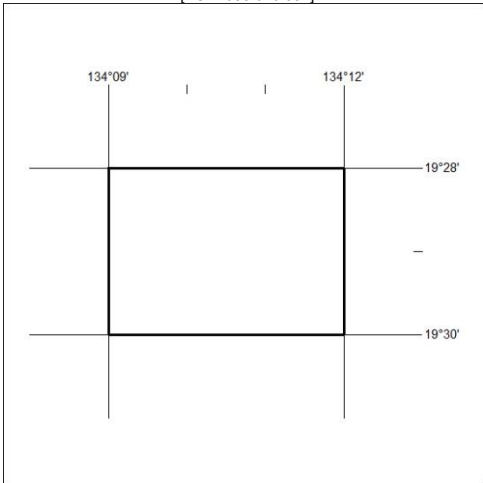

Area granted is indicated above. The titleholder is not permitted to exercise occupational rights on any land that is subject to a development title, or an application for a development title. Any land the subject of a Reserved Land gazettal under the *Mineral Titles Act* and all land vested in the Commonwealth of Australia is also excluded by description but not excised from the grant area.

425/24