

MN93-24

DARWIN

01 August 2024

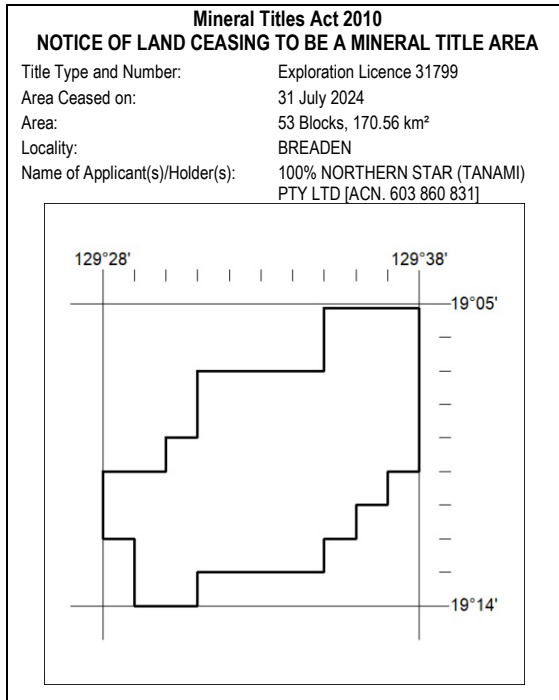

220/24

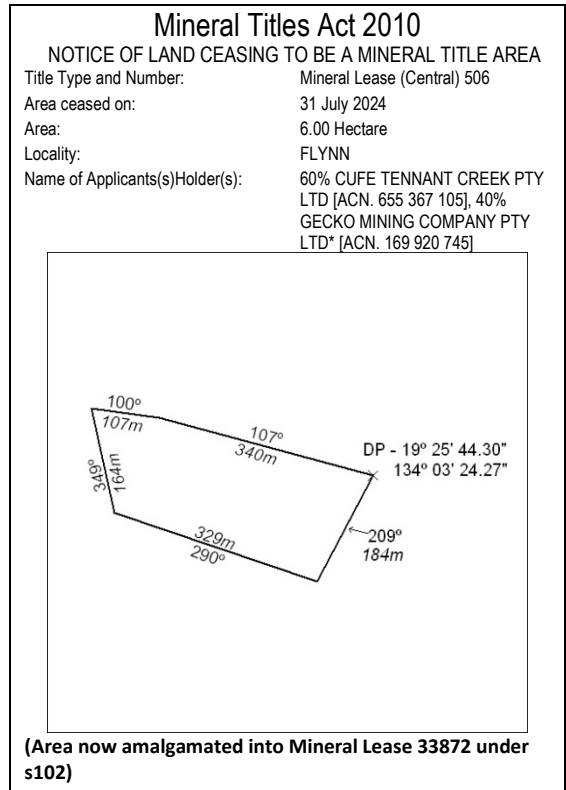

222/24

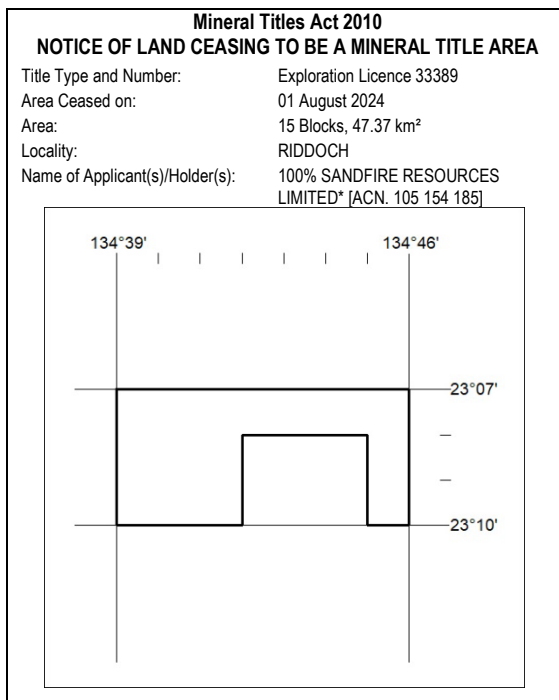

221/24

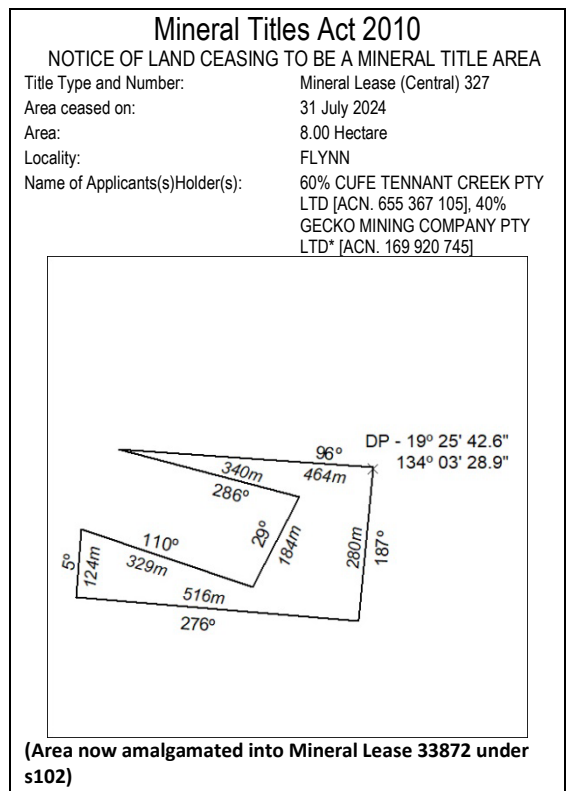

223/24

MN93-24

DARWIN

01 August 2024

Mineral Titles Act 2010

NOTICE OF LAND CEASING TO BE A MINERAL TITLE AREA

Title Type and Number: Mineral Lease (Central) 326
 Area ceased on: 31 July 2024
 Area: 14.00 Hectare
 Locality: FLYNN
 Name of Applicants(s)/Holder(s): 60% CUFÉ TENNANT CREEK PTY LTD [ACN. 655 367 105], 40% GECKO MINING COMPANY PTY LTD* [ACN. 169 920 745]

(Area now amalgamated into Mineral Lease 33872 under s102)

224/24

Mineral Titles Act 2010

NOTICE OF LAND CEASING TO BE A MINERAL TITLE AREA

Title Type and Number: Mineral Lease (Central) 324
 Area ceased on: 31 July 2024
 Area: 15.00 Hectare
 Locality: FLYNN
 Name of Applicants(s)/Holder(s): 60% CUFÉ TENNANT CREEK PTY LTD [ACN. 655 367 105], 40% GECKO MINING COMPANY PTY LTD* [ACN. 169 920 745]

(Area now amalgamated into Mineral Lease 33872 under s102)

226/24

Mineral Titles Act 2010

NOTICE OF LAND CEASING TO BE A MINERAL TITLE AREA

Title Type and Number: Mineral Lease (Central) 325
 Area ceased on: 31 July 2024
 Area: 13.00 Hectare
 Locality: FLYNN
 Name of Applicants(s)/Holder(s): 60% CUFÉ TENNANT CREEK PTY LTD [ACN. 655 367 105], 40% GECKO MINING COMPANY PTY LTD* [ACN. 169 920 745]

(Area now amalgamated into Mineral Lease 33872 under s102)

225/24

Mineral Titles Act 2010

NOTICE OF LAND CEASING TO BE A MINERAL TITLE AREA

Title Type and Number: Mineral Lease (Central) 323
 Area ceased on: 31 July 2024
 Area: 15.00 Hectare
 Locality: FLYNN
 Name of Applicants(s)/Holder(s): 60% CUFÉ TENNANT CREEK PTY LTD [ACN. 655 367 105], 40% GECKO MINING COMPANY PTY LTD* [ACN. 169 920 745]

(Area now amalgamated into Mineral Lease 33872 under s102)

227/24

MN93-24

DARWIN

01 August 2024

Mineral Titles Act 2010
NOTICE OF LAND CEASING TO BE A MINERAL TITLE AREA

Title Type and Number: Mineral Lease (Central) 90
 Area ceased on: 31 July 2024
 Area: 16.00 Hectare
 Locality: FLYNN
 Name of Applicants(s)/Holder(s): 60% CUFÉ TENNANT CREEK PTY LTD [ACN. 655 367 105], 40% GECKO MINING COMPANY PTY LTD* [ACN. 169 920 745]

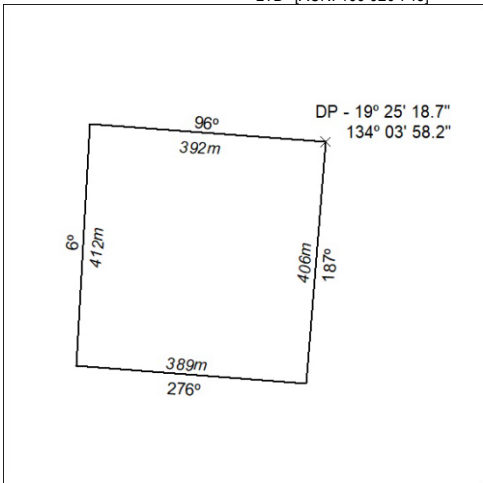

(Area now amalgamated into Mineral Lease 33872 under s102)

228/24

Mineral Titles Act 2010
NOTICE OF LAND CEASING TO BE A MINERAL TITLE AREA

Title Type and Number: Mineral Lease (Central) 87
 Area ceased on: 31 July 2024
 Area: 14.00 Hectare
 Locality: FLYNN
 Name of Applicants(s)/Holder(s): 60% CUFÉ TENNANT CREEK PTY LTD [ACN. 655 367 105], 40% GECKO MINING COMPANY PTY LTD* [ACN. 169 920 745]

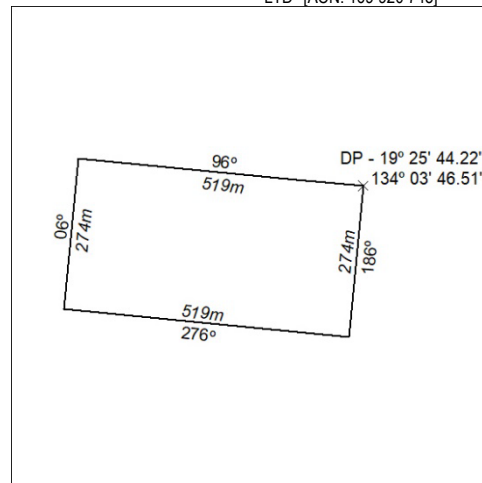

(Area now amalgamated into Mineral Lease 33872 under s102)

230/24

Mineral Titles Act 2010
NOTICE OF LAND CEASING TO BE A MINERAL TITLE AREA

Title Type and Number: Mineral Lease (Central) 89
 Area ceased on: 31 July 2024
 Area: 16.00 Hectare
 Locality: FLYNN
 Name of Applicants(s)/Holder(s): 60% CUFÉ TENNANT CREEK PTY LTD [ACN. 655 367 105], 40% GECKO MINING COMPANY PTY LTD* [ACN. 169 920 745]

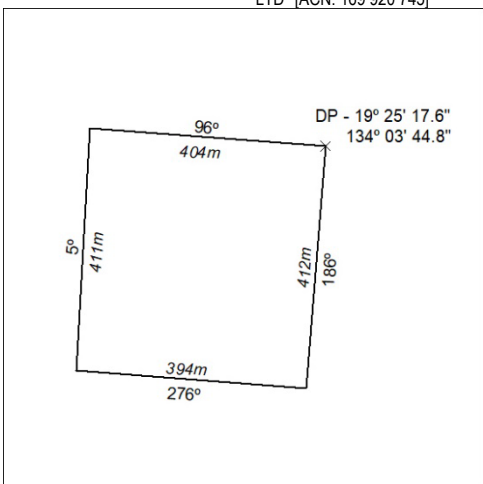

(Area now amalgamated into Mineral Lease 33872 under s102)

229/24

Mineral Titles Act 2010
NOTICE OF LAND CEASING TO BE A MINERAL TITLE AREA

Title Type and Number: Mineral Lease (Central) 88
 Area ceased on: 31 July 2024
 Area: 15.00 Hectare
 Locality: FLYNN
 Name of Applicants(s)/Holder(s): 60% CUFÉ TENNANT CREEK PTY LTD [ACN. 655 367 105], 40% GECKO MINING COMPANY PTY LTD* [ACN. 169 920 745]

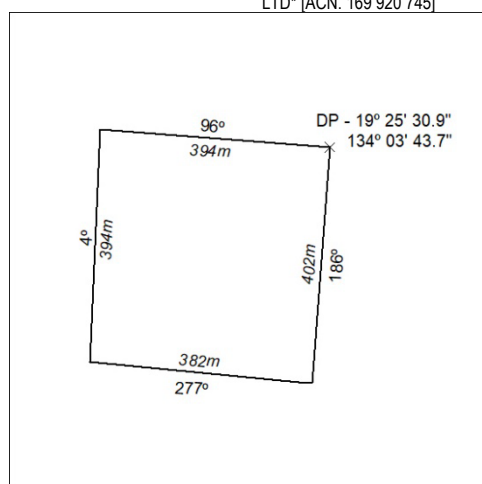

(Area now amalgamated into Mineral Lease 33872 under s102)

231/24

MN93-24

DARWIN

01 August 2024

Mineral Titles Act 2010

NOTICE OF LAND CEASING TO BE A MINERAL TITLE AREA

Title Type and Number: Mineral Lease (Central) 86
 Area ceased on: 31 July 2024
 Area: 16.00 Hectare
 Locality: FLYNN
 Name of Applicants(s)/Holder(s): 60% CUFÉ TENNANT CREEK PTY LTD [ACN. 655 367 105], 40% GECKO MINING COMPANY PTY LTD* [ACN. 169 920 745]

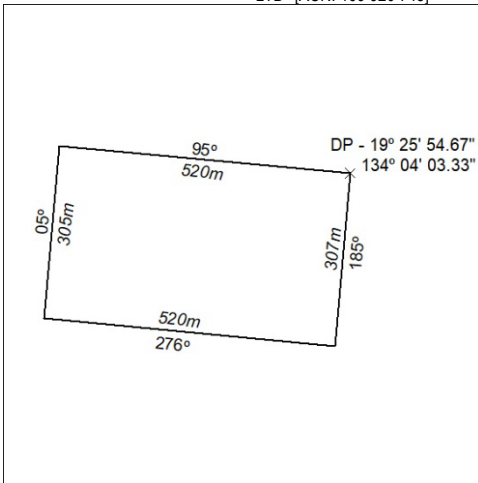

(Area now amalgamated into Mineral Lease 33872 under s102)

232/24

Mineral Titles Act 2010

NOTICE OF LAND CEASING TO BE A MINERAL TITLE AREA

Title Type and Number: Mineral Lease (Central) 78
 Area ceased on: 31 July 2024
 Area: 16.00 Hectare
 Locality: FLYNN
 Name of Applicants(s)/Holder(s): 60% CUFÉ TENNANT CREEK PTY LTD [ACN. 655 367 105], 40% GECKO MINING COMPANY PTY LTD* [ACN. 169 920 745]

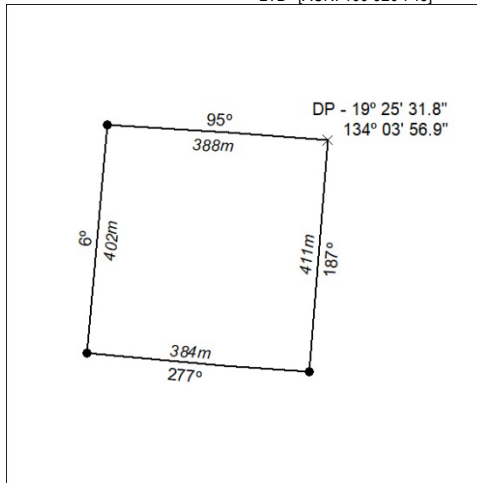

(Area now amalgamated into Mineral Lease 33872 under s102)

234/24

Mineral Titles Act 2010

NOTICE OF LAND CEASING TO BE A MINERAL TITLE AREA

Title Type and Number: Mineral Lease (Central) 85
 Area ceased on: 31 July 2024
 Area: 16.00 Hectare
 Locality: FLYNN
 Name of Applicants(s)/Holder(s): 60% CUFÉ TENNANT CREEK PTY LTD [ACN. 655 367 105], 40% GECKO MINING COMPANY PTY LTD* [ACN. 169 920 745]

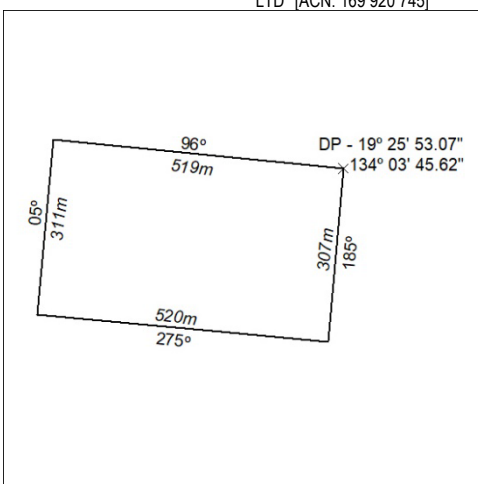

(Area now amalgamated into Mineral Lease 33872 under s102)

233/24

Mineral Titles Act 2010

NOTICE OF LAND CEASING TO BE A MINERAL TITLE AREA

Title Type and Number: Mineral Lease (Central) 70
 Area ceased on: 31 July 2024
 Area: 17.00 Hectare
 Locality: FLYNN
 Name of Applicants(s)/Holder(s): 60% CUFÉ TENNANT CREEK PTY LTD [ACN. 655 367 105], 40% GECKO MINING COMPANY PTY LTD* [ACN. 169 920 745]

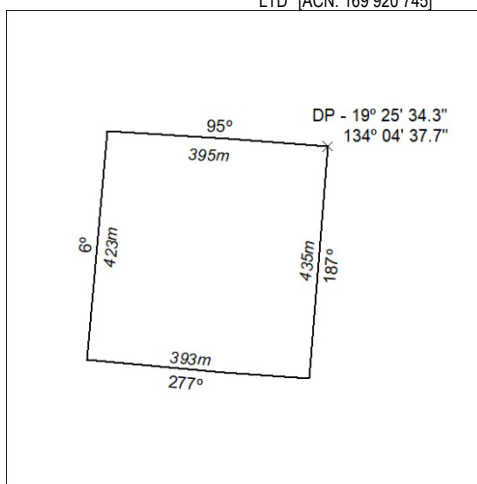

(Area now amalgamated into Mineral Lease 33872 under s102)

235/24

MN93-24

DARWIN

01 August 2024

Mineral Titles Act 2010

NOTICE OF LAND CEASING TO BE A MINERAL TITLE AREA

Title Type and Number: Mineral Lease (Central) 69
 Area ceased on: 31 July 2024
 Area: 17.00 Hectare
 Locality: FLYNN
 Name of Applicants(s)/Holder(s): 60% CUFÉ TENNANT CREEK PTY LTD [ACN. 655 367 105], 40% GECKO MINING COMPANY PTY LTD* [ACN. 169 920 745]

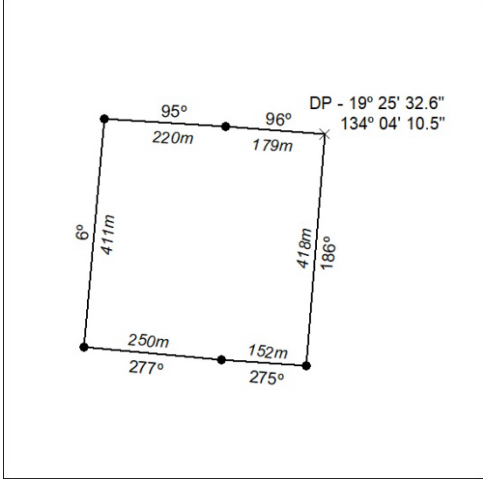

(Area now amalgamated into Mineral Lease 33872 under s102)

236/24

Mineral Titles Act 2010

NOTICE OF LAND CEASING TO BE A MINERAL TITLE AREA

Title Type and Number: Mineral Lease (Central) 21
 Area ceased on: 31 July 2024
 Area: 17.00 Hectare
 Locality: FLYNN
 Name of Applicants(s)/Holder(s): 60% CUFÉ TENNANT CREEK PTY LTD [ACN. 655 367 105], 40% GECKO MINING COMPANY PTY LTD* [ACN. 169 920 745]

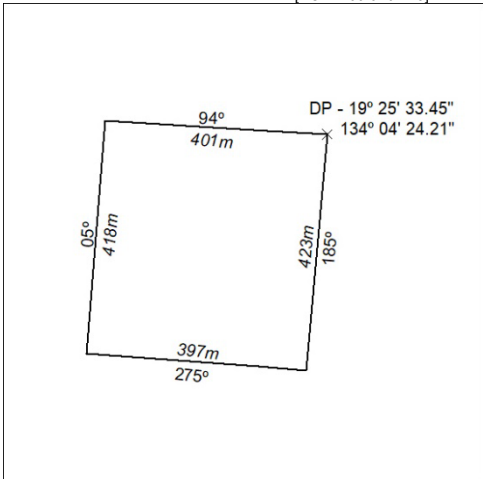

(Area now amalgamated into Mineral Lease 33872 under s102)

237/24