

DARWIN
WATERFRONT

Harmony Soiree

Saturday 28 May 2016

Darwin Waterfront Precinct

4pm – 8.30pm



**Come and celebrate
Darwin's cultural
diversity!**

**With fun filled activities,
dazzling entertainment and
delicious food from different
parts of the world.**

Decorate your floating lantern, release it with the lantern flotilla and watch the fireworks finale!

Prizes will be awarded for the best handmade lanterns.

*Refer to the reverse side for entry information
and instructions on how to fold a lantern.*

For more information please visit
www.multicultural.nt.gov.au

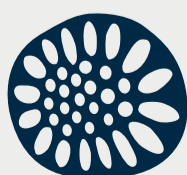

DARWIN WATERFRONT



How to make a floating lantern

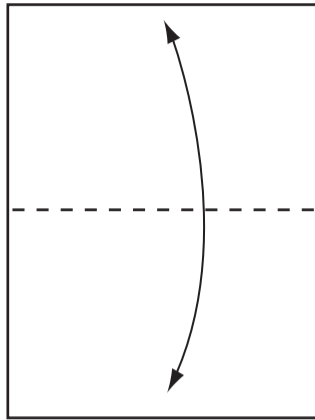

1. Fold in half, crease, open.

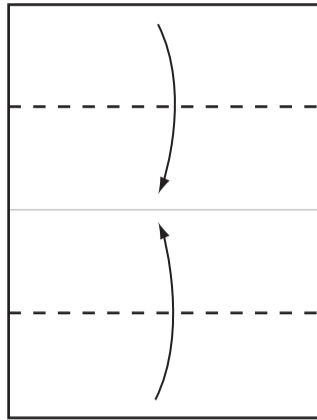

2. Fold top and bottom into the centre crease.

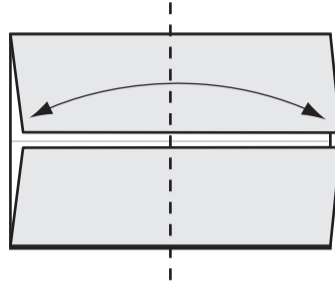

3. Fold in half, crease, open.

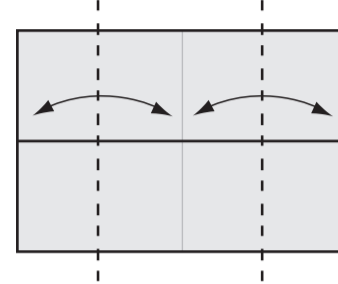

4. Fold outer edges into the centre crease, open.

Floating Lantern Competition

Name: _____

Age: ○

Phone number: _____

How to enter the Floating Lantern Competition:

1. Make a floating lantern using the instructions on this page, or design your own!
2. Colour and decorate.
3. Write your name, age and contact phone number on the lantern.
4. Come to the Darwin Waterfront Harmony Soiree and deliver your lantern to the lantern tent next to the information stall by 6:30pm.
5. Winners will be announced at the lagoon and contacted via telephone.
6. Pick up a floating candle from the information stall.
7. Release your lantern into the lagoon with everyone at 8.00pm to the backdrop of a spectacular fireworks display.

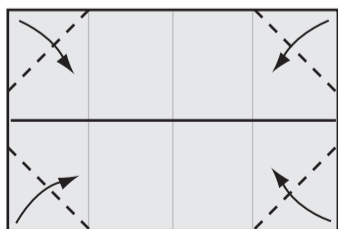

5. Fold each corner into the crease from step 4.

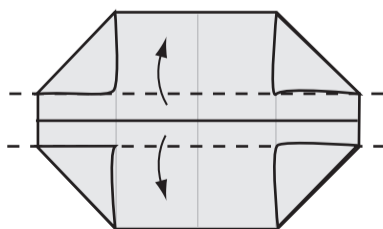

6. Fold inside edges outwards towards corner triangles, crease.

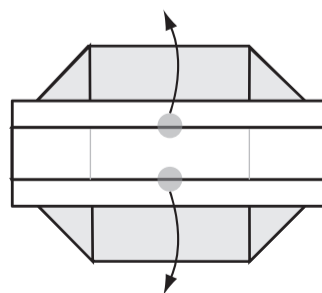

7. At points shown in picture, pull up and open outwards.

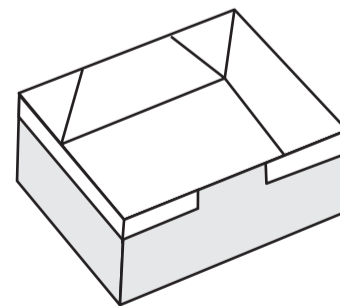

8. Pinch corners to form a strong rectangle shape. Finished!